

ISP[®]

International Sound Products

***service
manual***

**Radio
Recorder**

RC 2003



TELESCOPIC ANT.

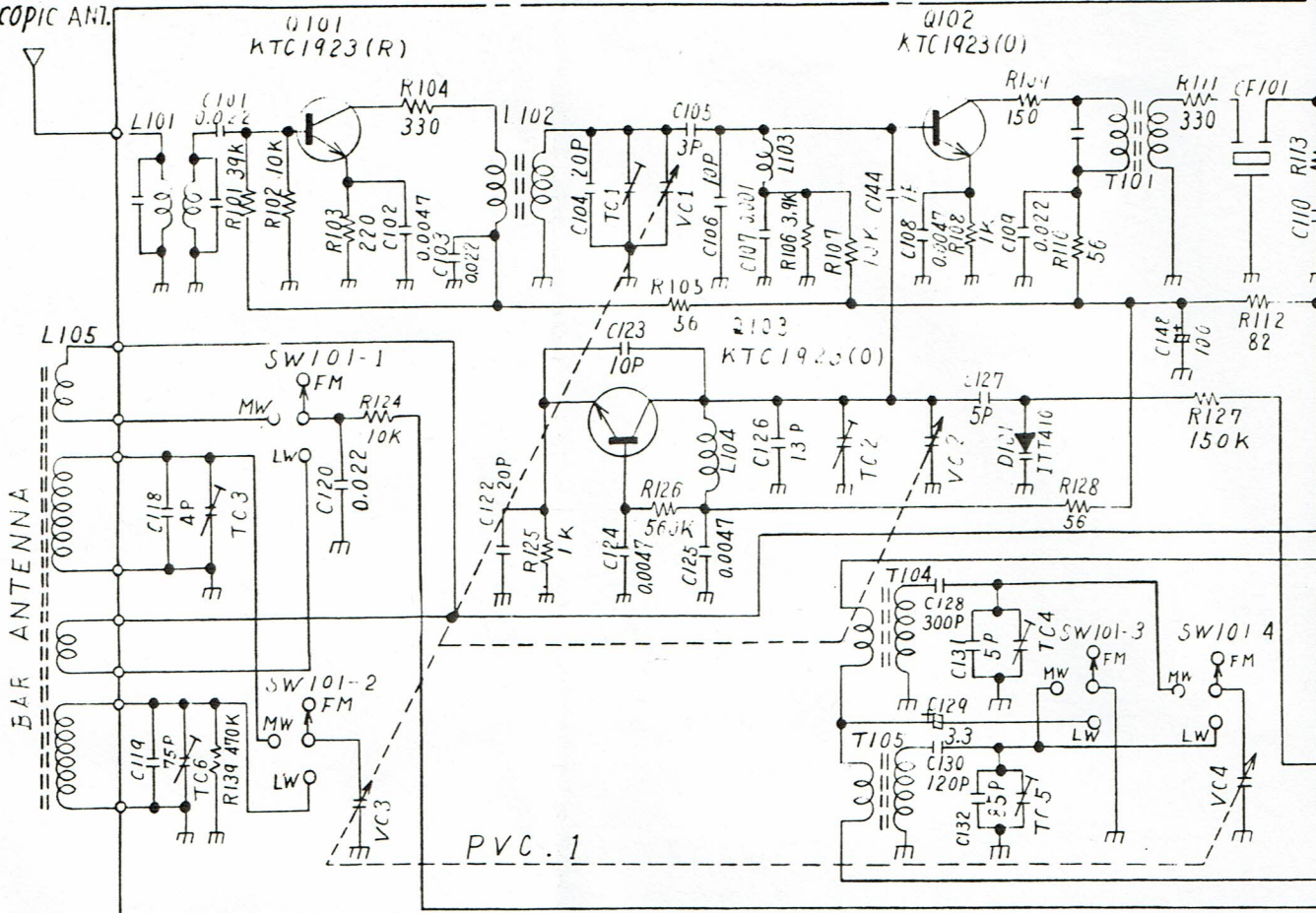

PVC.1

CONDENSER MIC

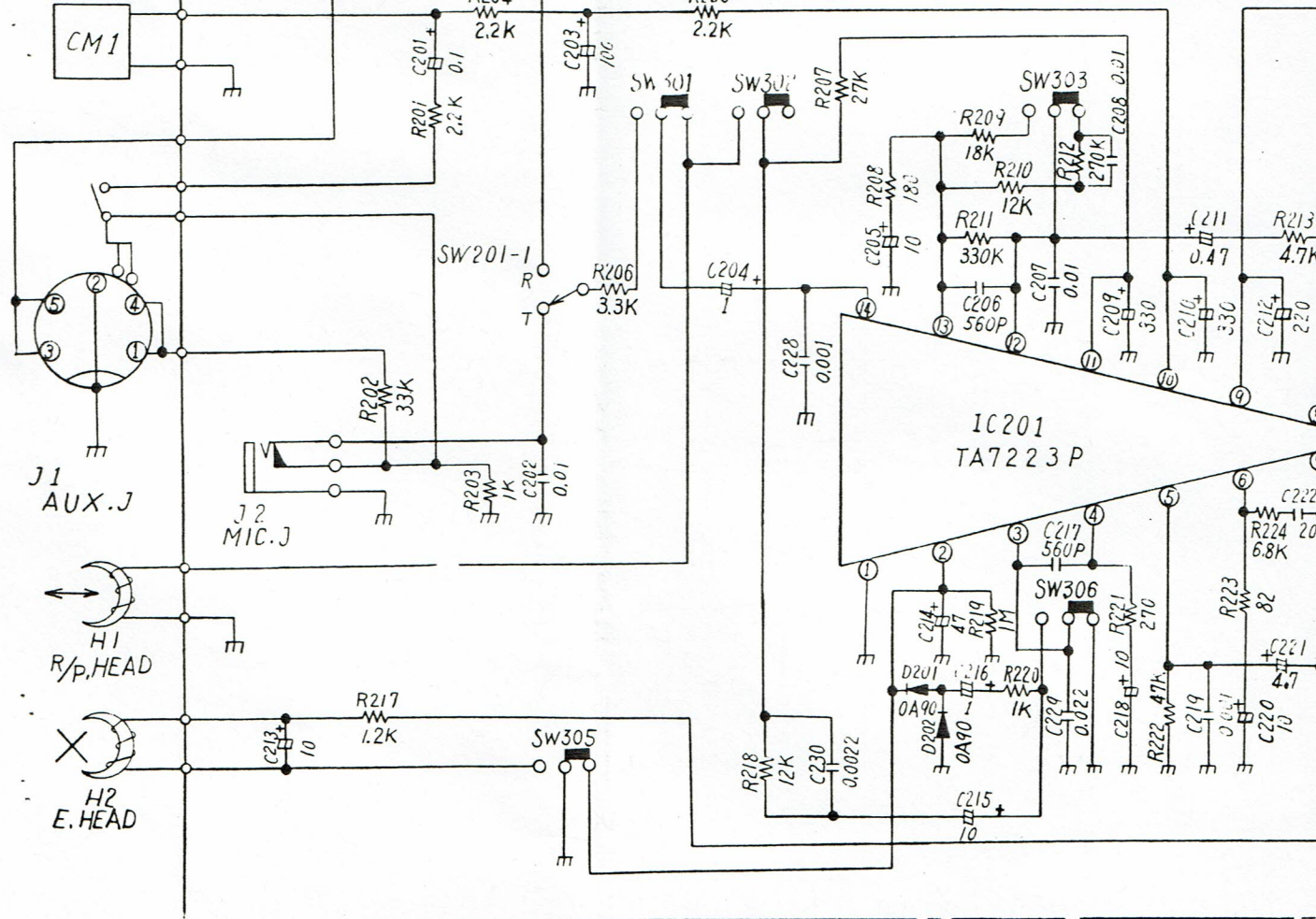

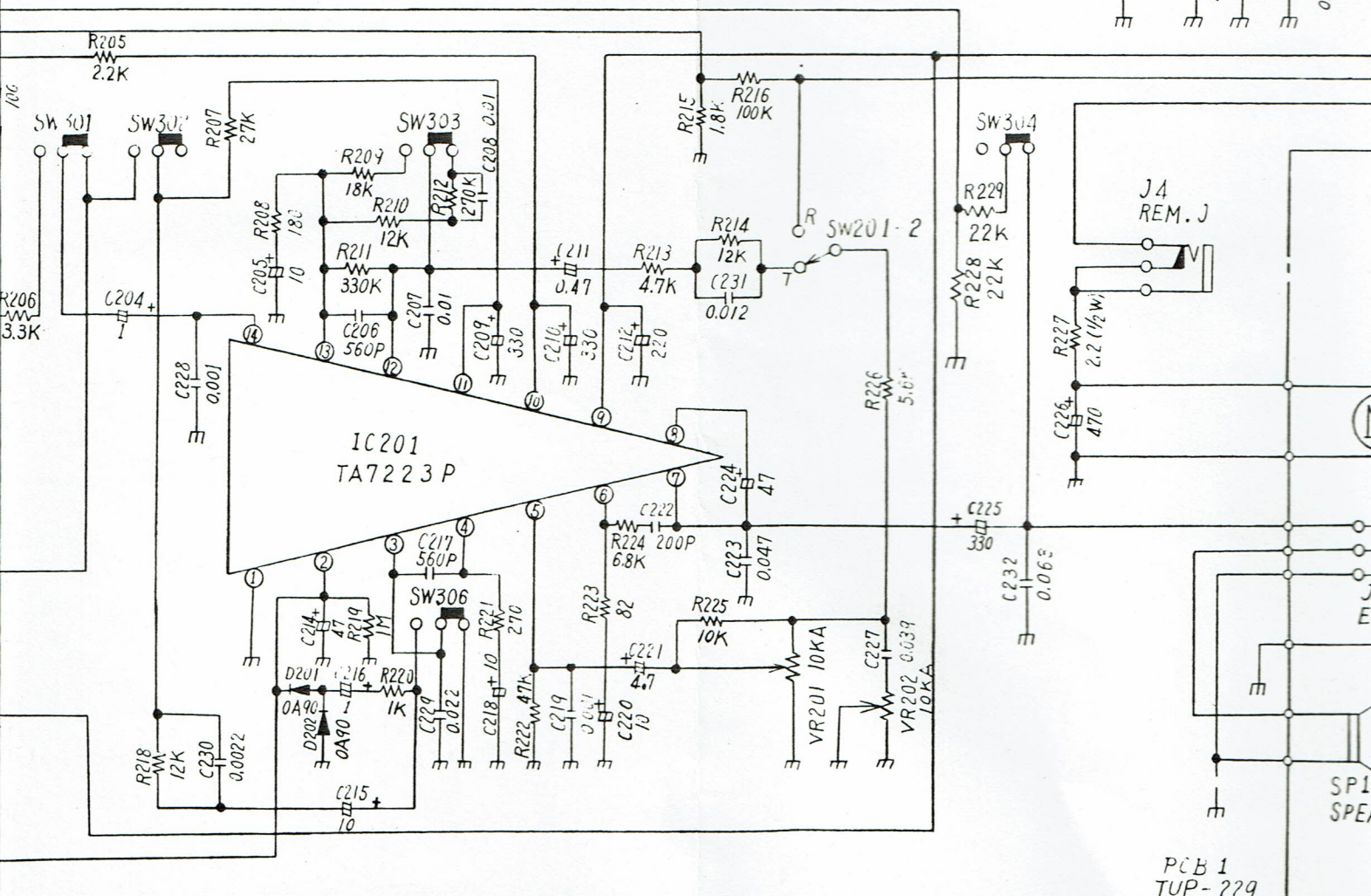
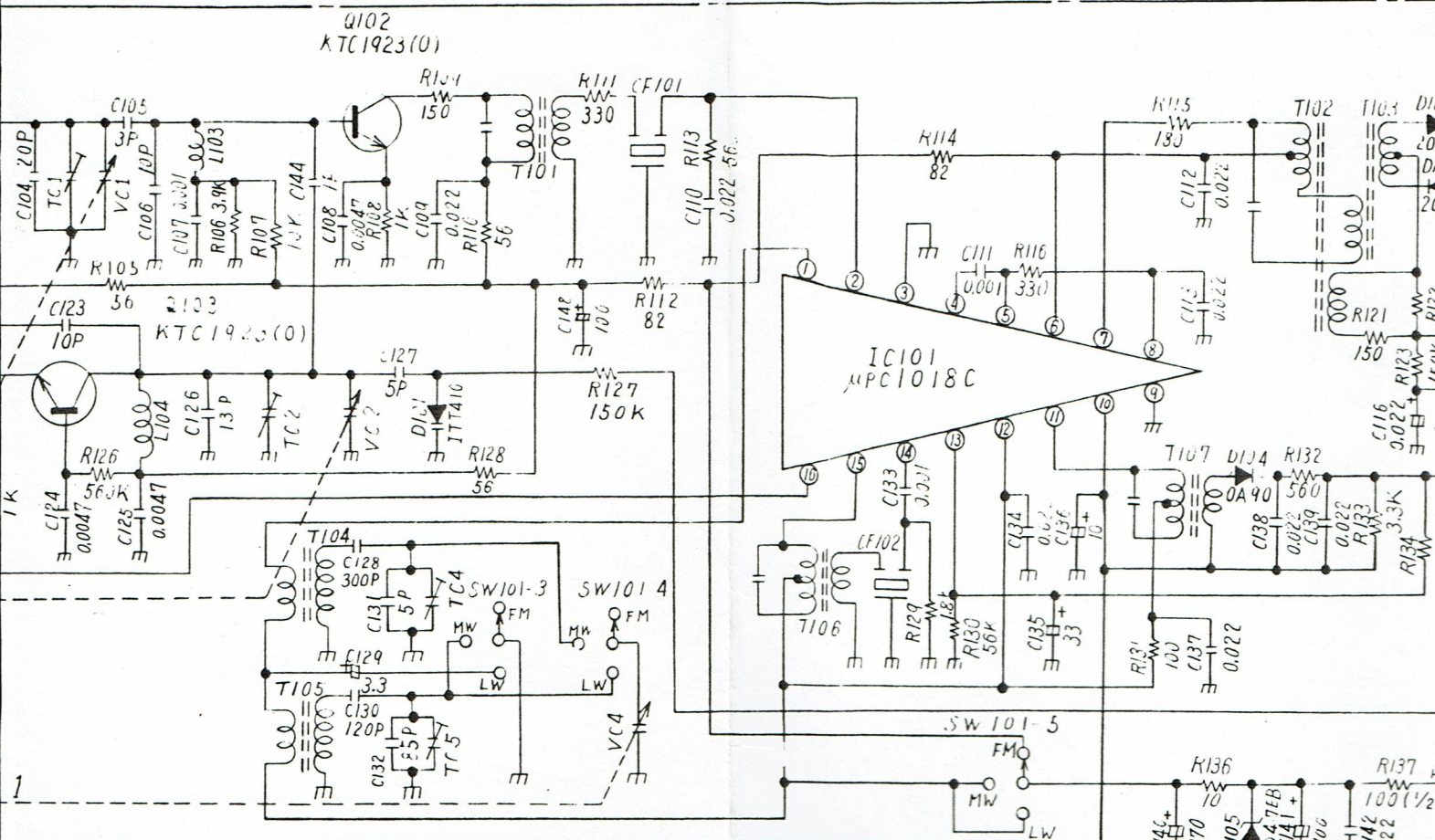

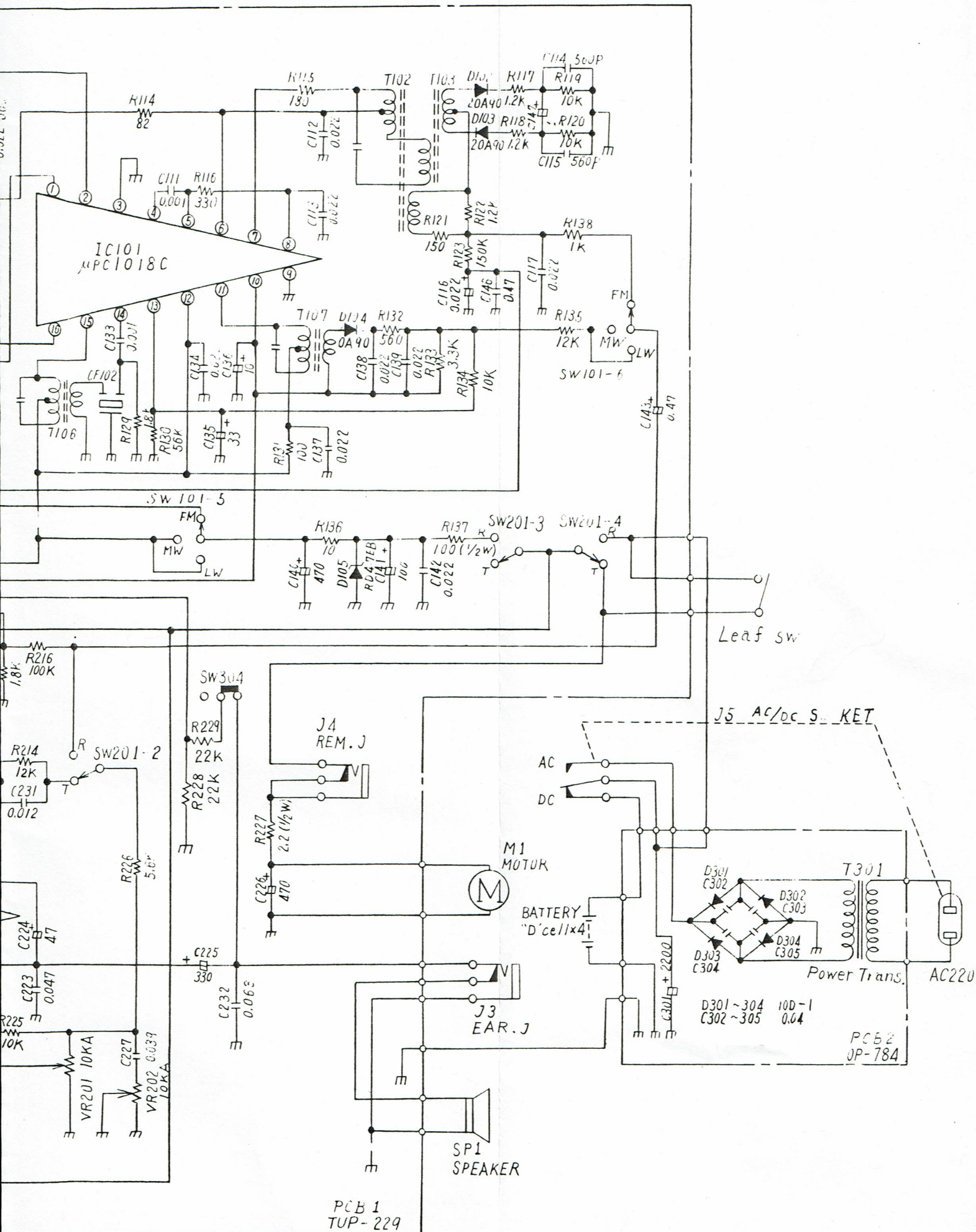

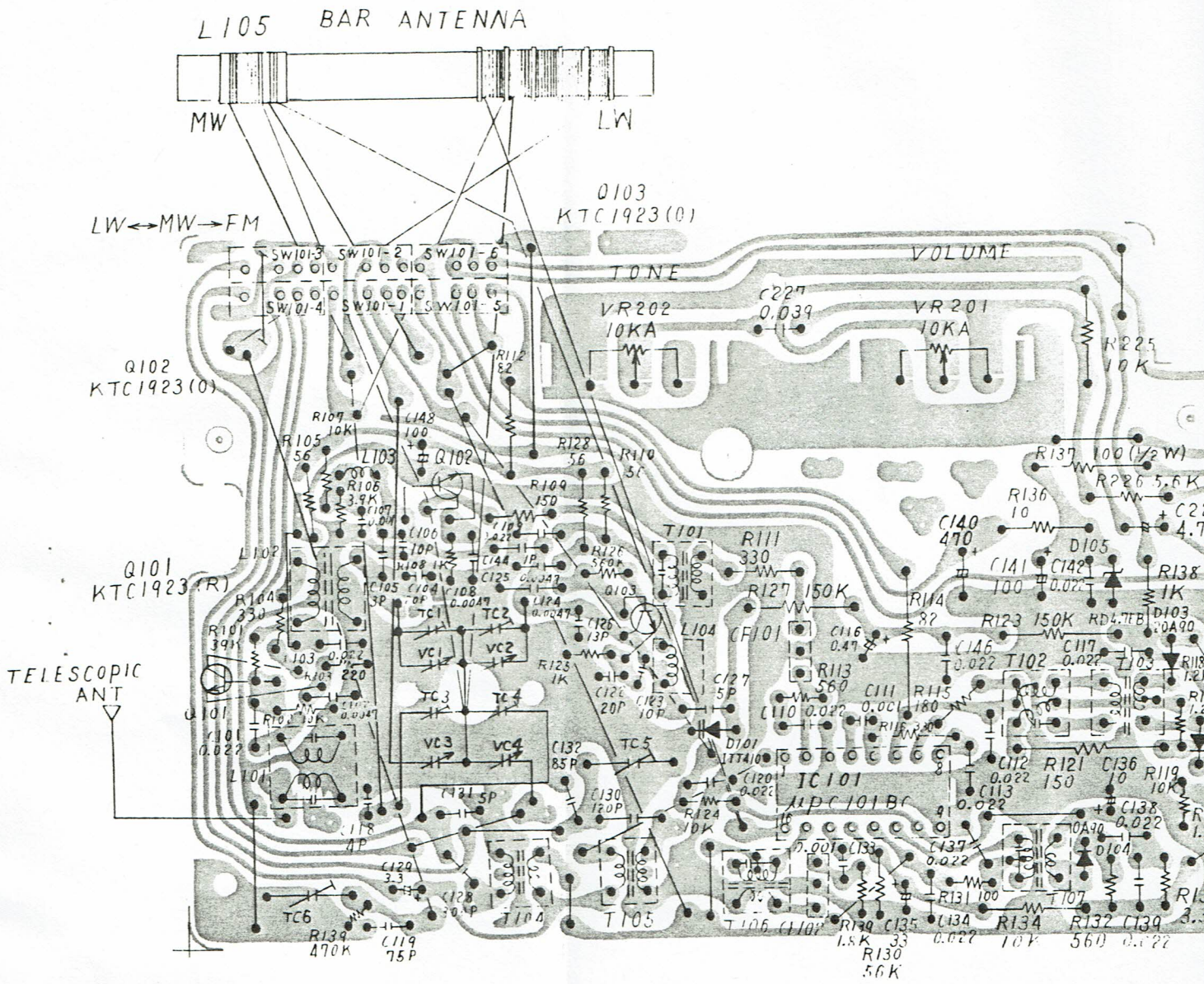

P.C.B. 1
 TUP-229
 Bottom View



0103
KTC1923(0)

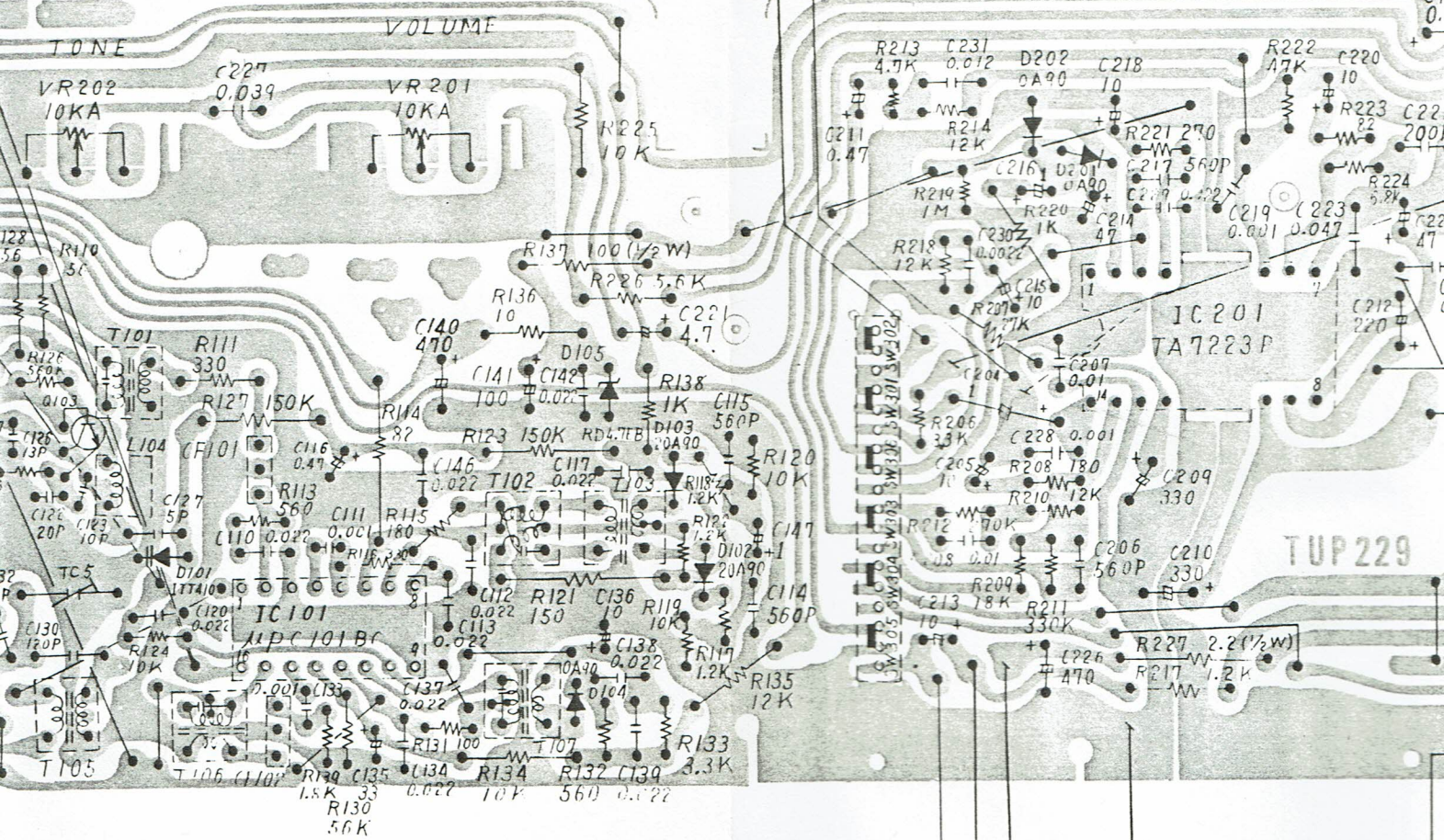

H1
R.P. HEAD

P.C.B. 1
TUP-229
Bottom View

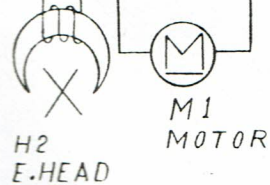

TUP229

H1
R.P. HEAD

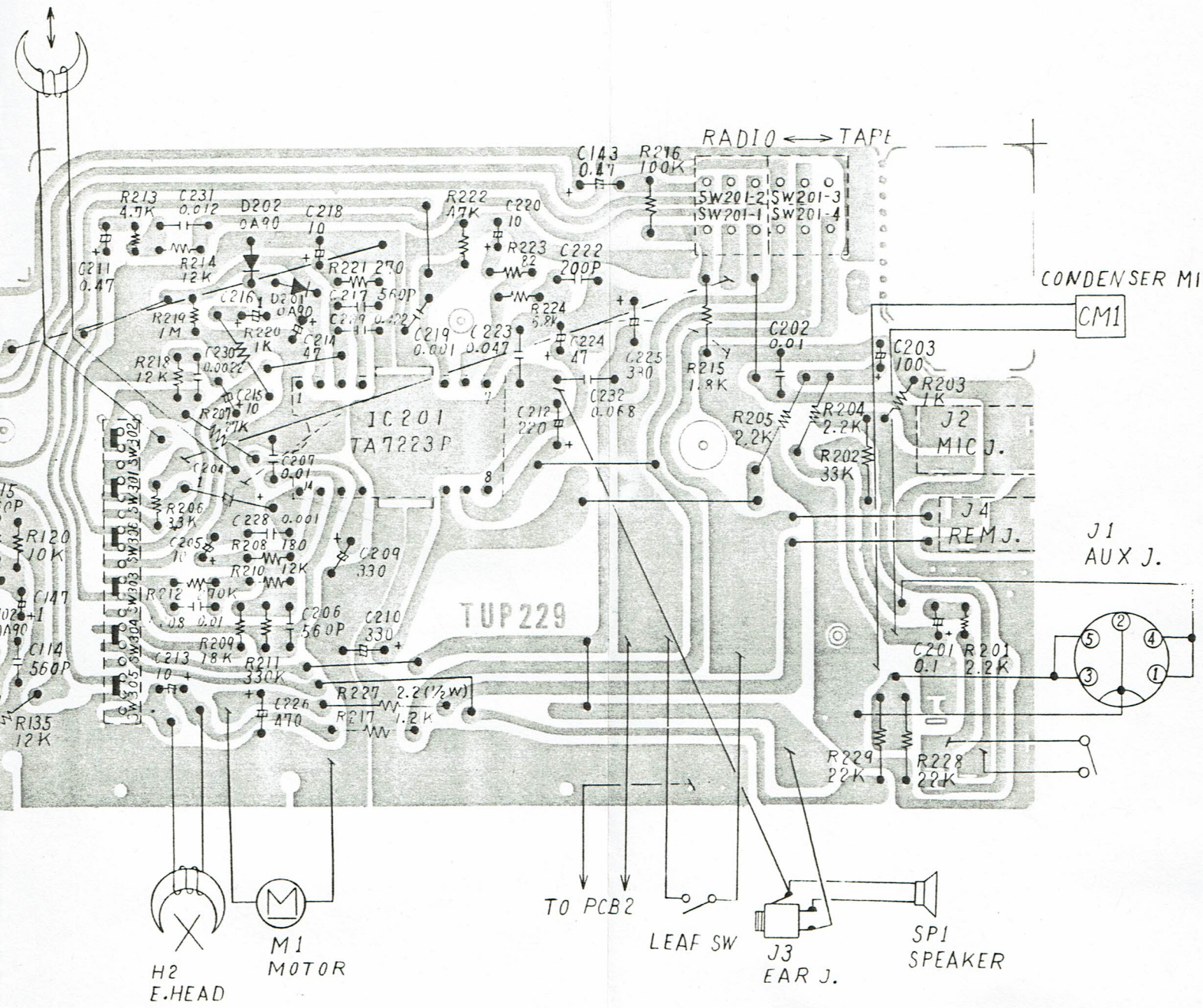

F.C.B.2
BOTTOM VIEW

