

ISP[®]

International Sound Products

ELECTRO-DENIS sprl
Radio-TV-HiFi-Electro Ménager
Faubourg de France 2
6830 Bouillon
061 - 466 352

service manual

Stereo

Radio recorder

MW/LW/MF

STR 460



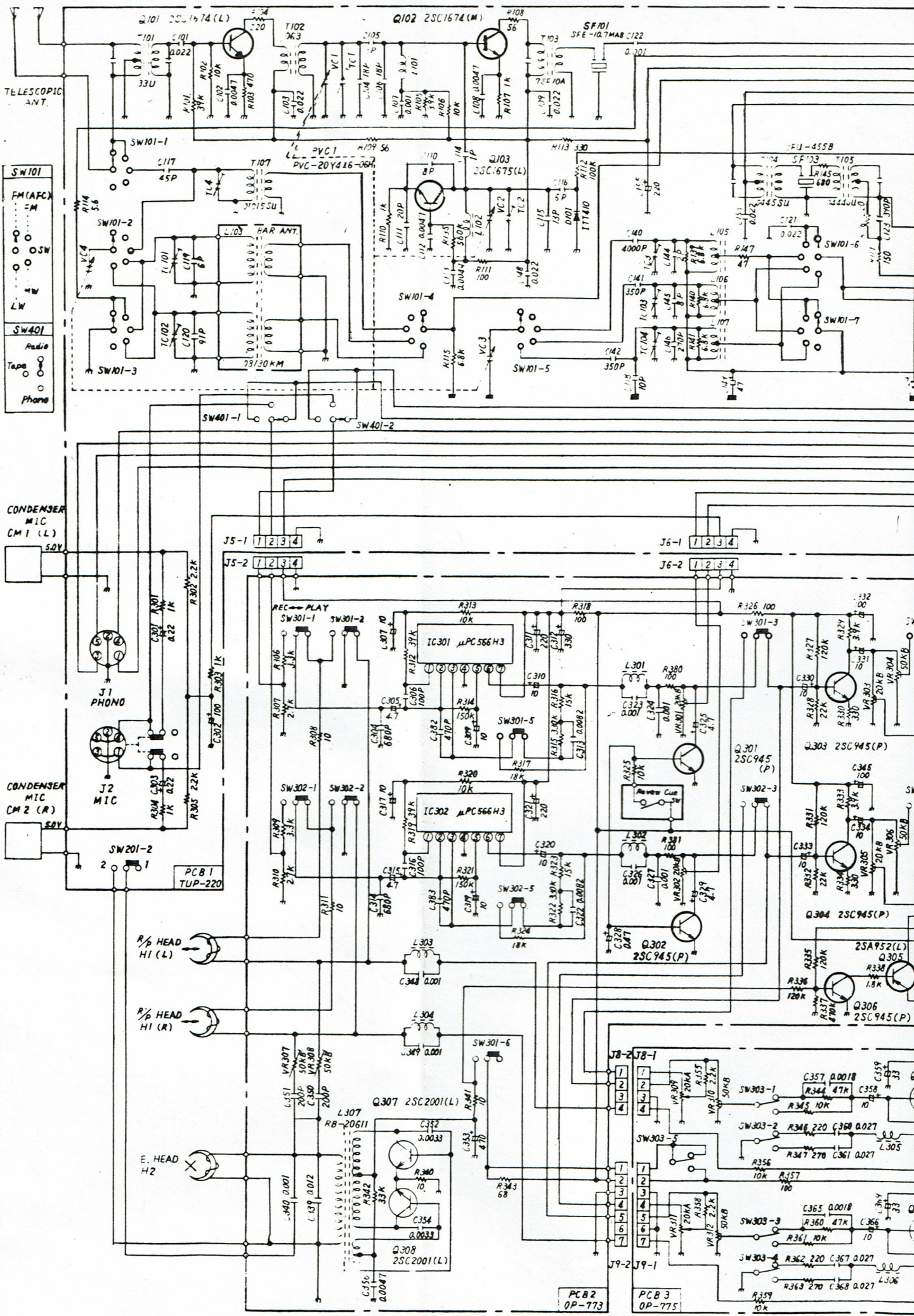

SW101

- FM (AFC)
- FM
- OSW
- HW
- LW

SW401

- Radio
- Tape
- Phone

CONDENSER MIC CM1 (L)

CONDENSER MIC CM2 (R)

J1 PHONO

J2 MIC

R/2 HEAD HI (L)

R/2 HEAD HI (R)

E. HEAD H2

PCB1 TUP-220

PCB2 OP-773

PCB3 OP-775

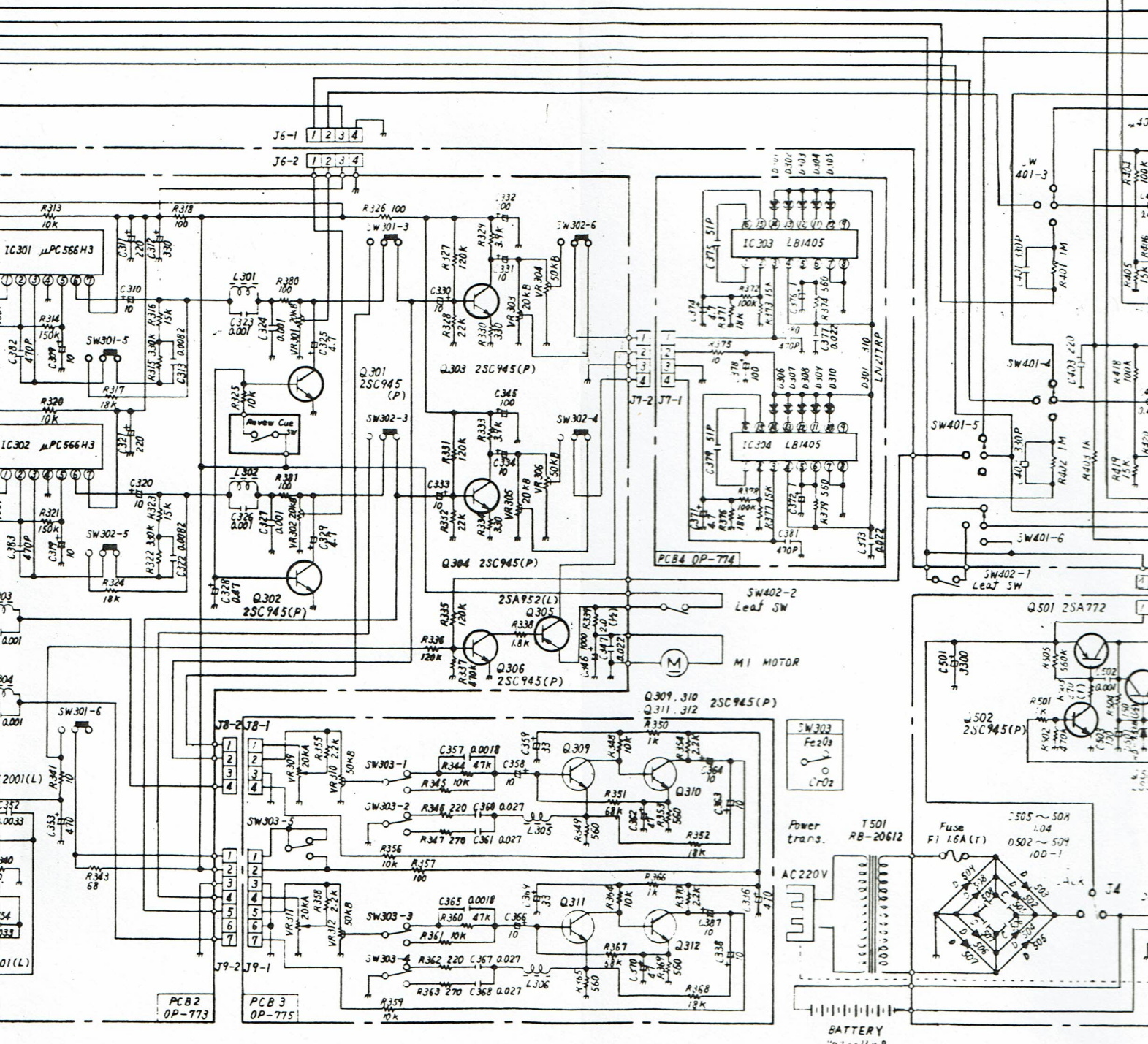
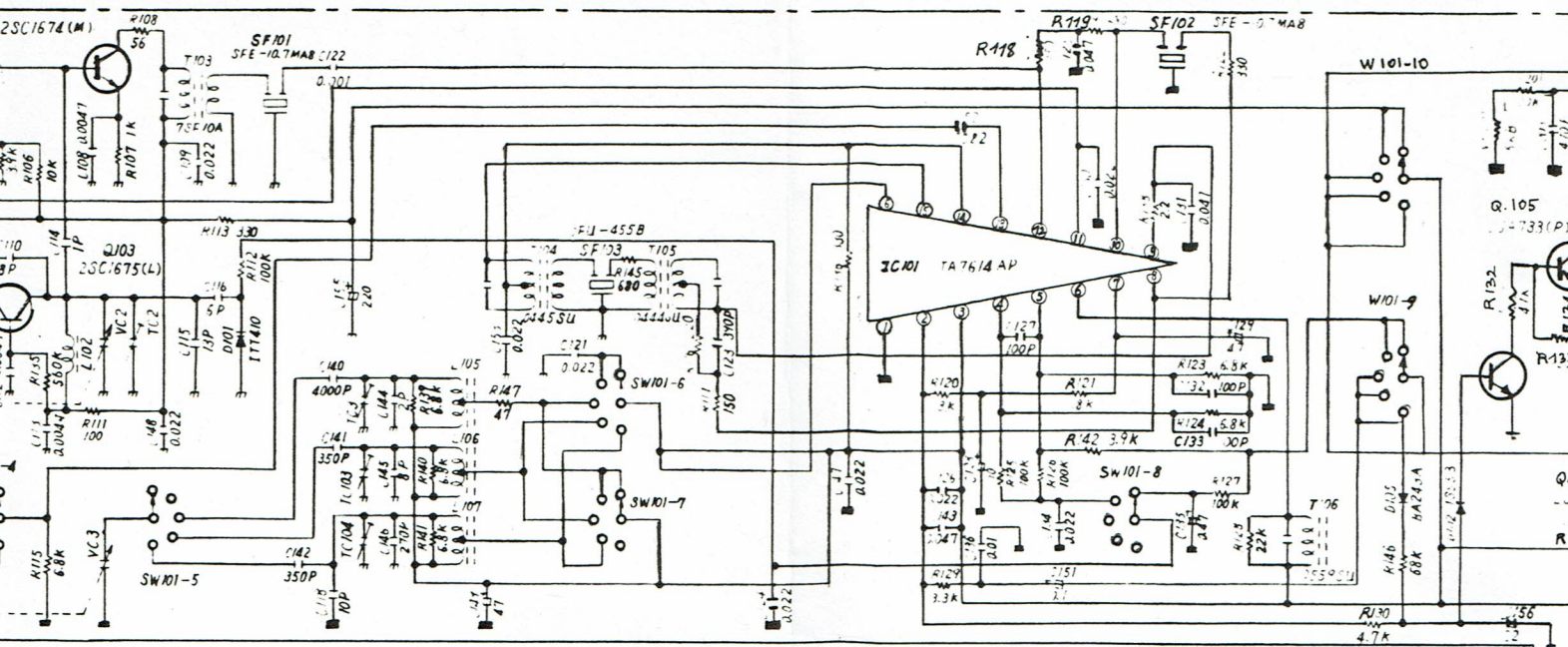

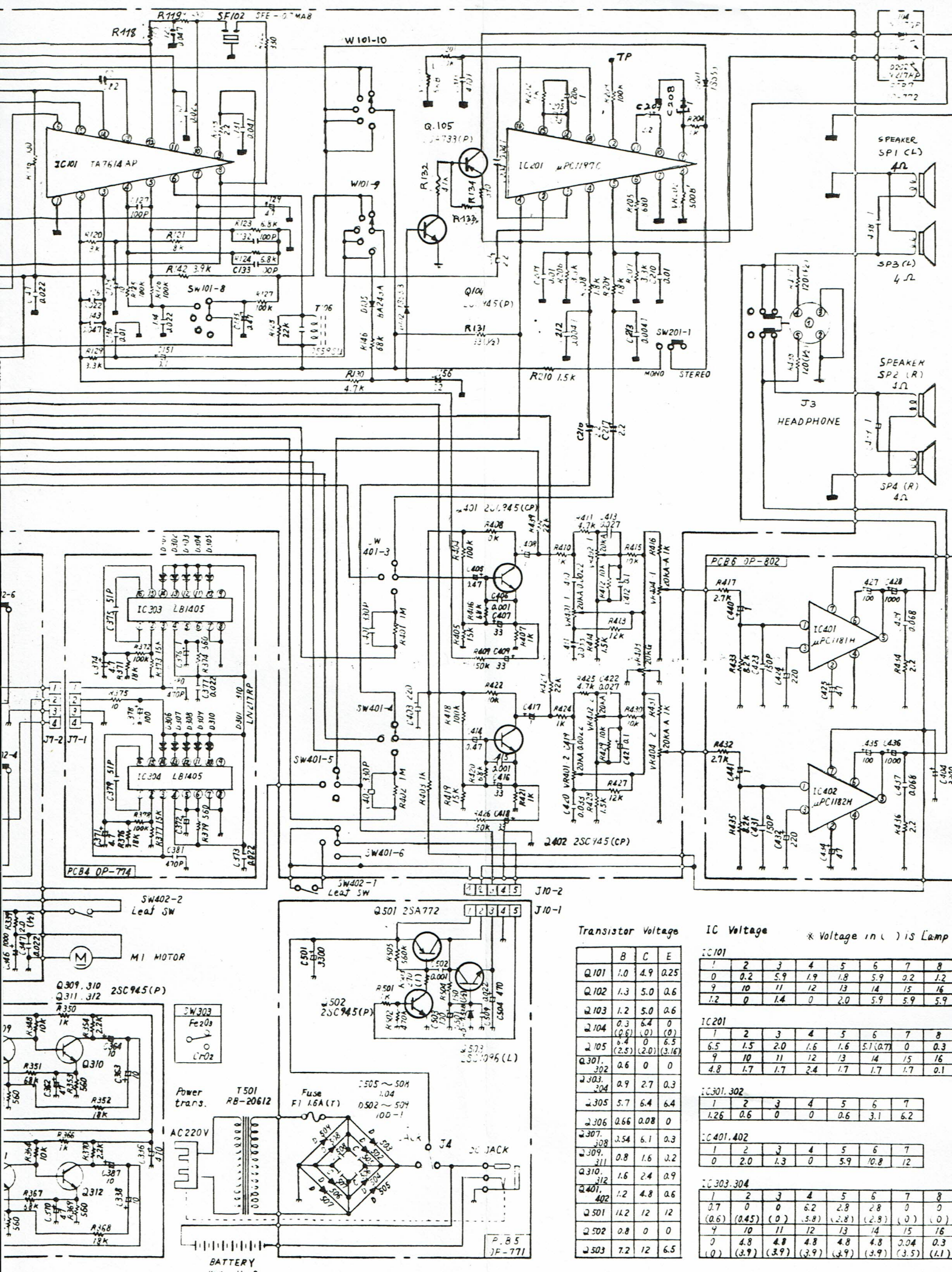

Transistor Voltage

	B	C	E
Q101	1.0	4.9	0.25
Q102	1.3	5.0	0.6
Q103	1.2	5.0	0.6
Q104	0.3	6.4	0
Q105	6.4	0	6.3
Q301, Q302	0.6	0	0
Q303, Q304	0.9	2.7	0.3
Q205	5.7	6.4	6.4
Q206	0.66	0.08	0
Q307, Q308	2.54	6.1	0.3
Q309, Q311	0.8	1.6	0.2
Q310, Q312	1.6	2.4	0.9
Q401, Q402	1.2	4.8	0.6
Q501	12	12	12
Q502	0.8	0	0
Q503	7.2	12	6.5

IC Voltage

* Voltage in () is Lamp

IC101								
1	2	3	4	5	6	7	8	
0	0.2	5.9	1.9	1.8	5.9	0.2	1.2	
9	10	11	12	13	14	15	16	
1.2	0	1.4	0	2.0	5.9	5.9	5.9	

IC201								
1	2	3	4	5	6	7	8	
6.5	1.5	2.0	1.6	1.6	5.1(0.7)	0	0.3	
9	10	11	12	13	14	15	16	
4.8	1.7	1.7	2.4	1.7	1.7	1.7	0.1	

IC301, 302							
1	2	3	4	5	6	7	
1.26	0.6	0	0	0.6	3.1	6.2	

IC401, 402							
1	2	3	4	5	6	7	
0	2.0	1.3	0	5.9	10.8	12	

IC303, 304								
1	2	3	4	5	6	7	8	
0.7	0	0	6.2	2.8	2.8	0	0	
(0.6)	(0.45)	(0)	(3.8)	(2.8)	(2.8)	(0)	(0)	
4	10	11	12	13	14	15	16	
0	4.8	4.8	4.8	4.8	4.8	0.04	0.3	
(0)	(3.9)	(3.9)	(3.9)	(3.9)	(3.9)	(3.5)	(1.1)	

PCB2

PCB6

Q102 2SC1674 (M) Q103 2SC1675 (L)

Q101 2SC1674 (L)

VOLUME 20
VR404

TUP-220

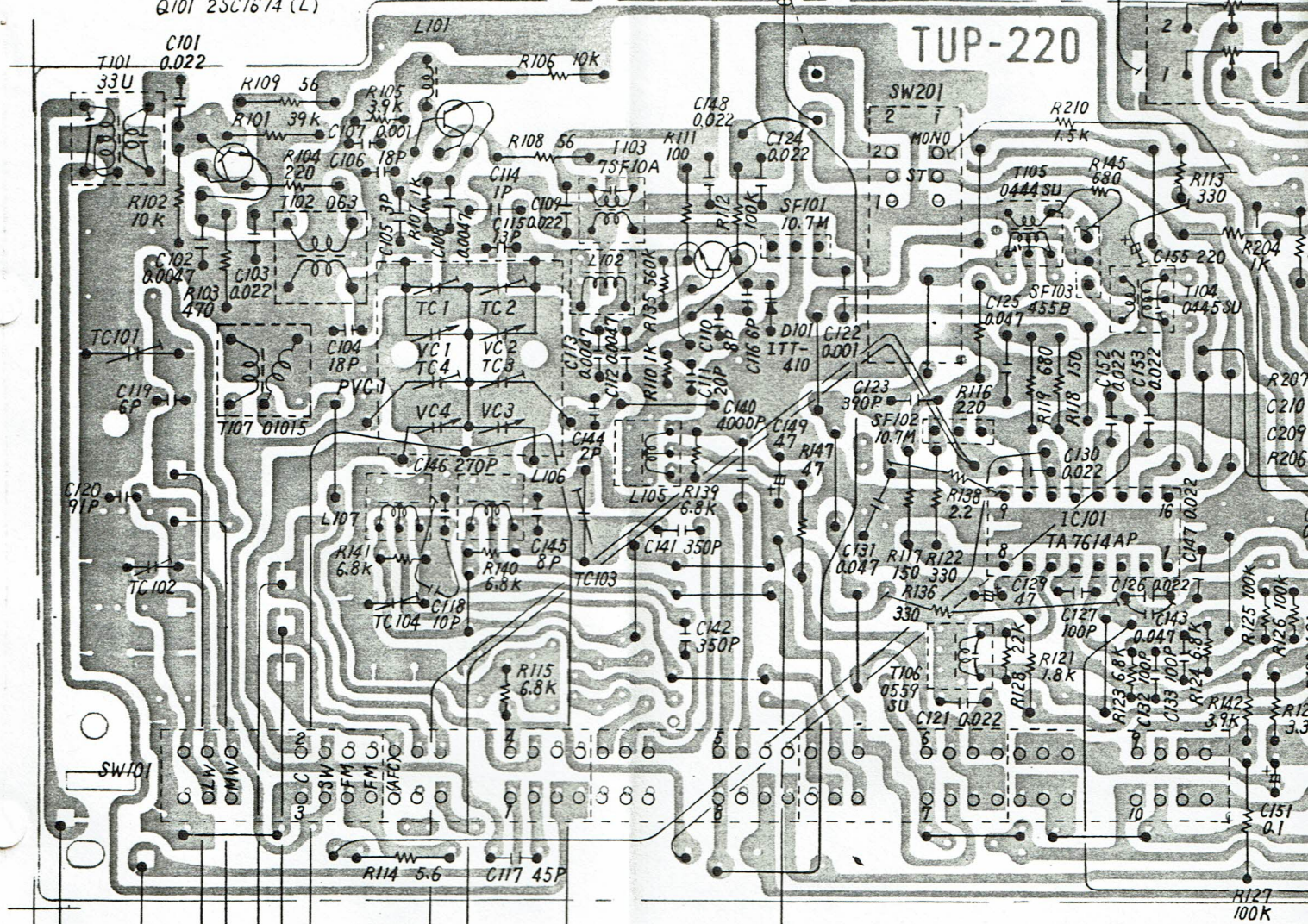

TELESCOPIC ANT.

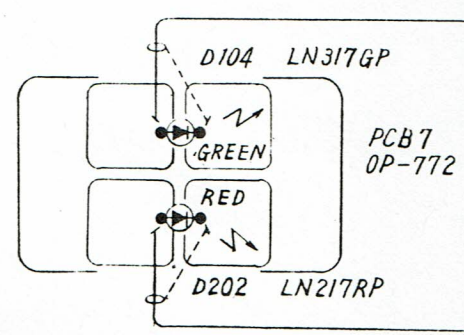
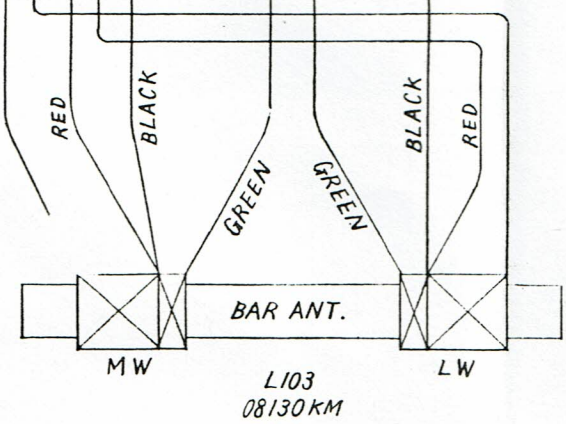

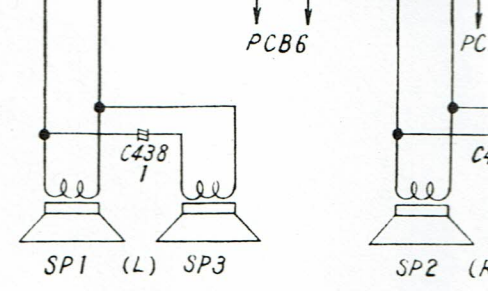
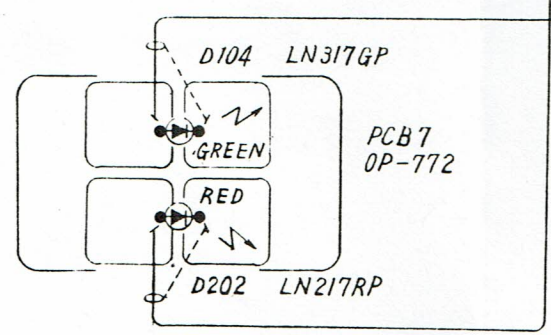
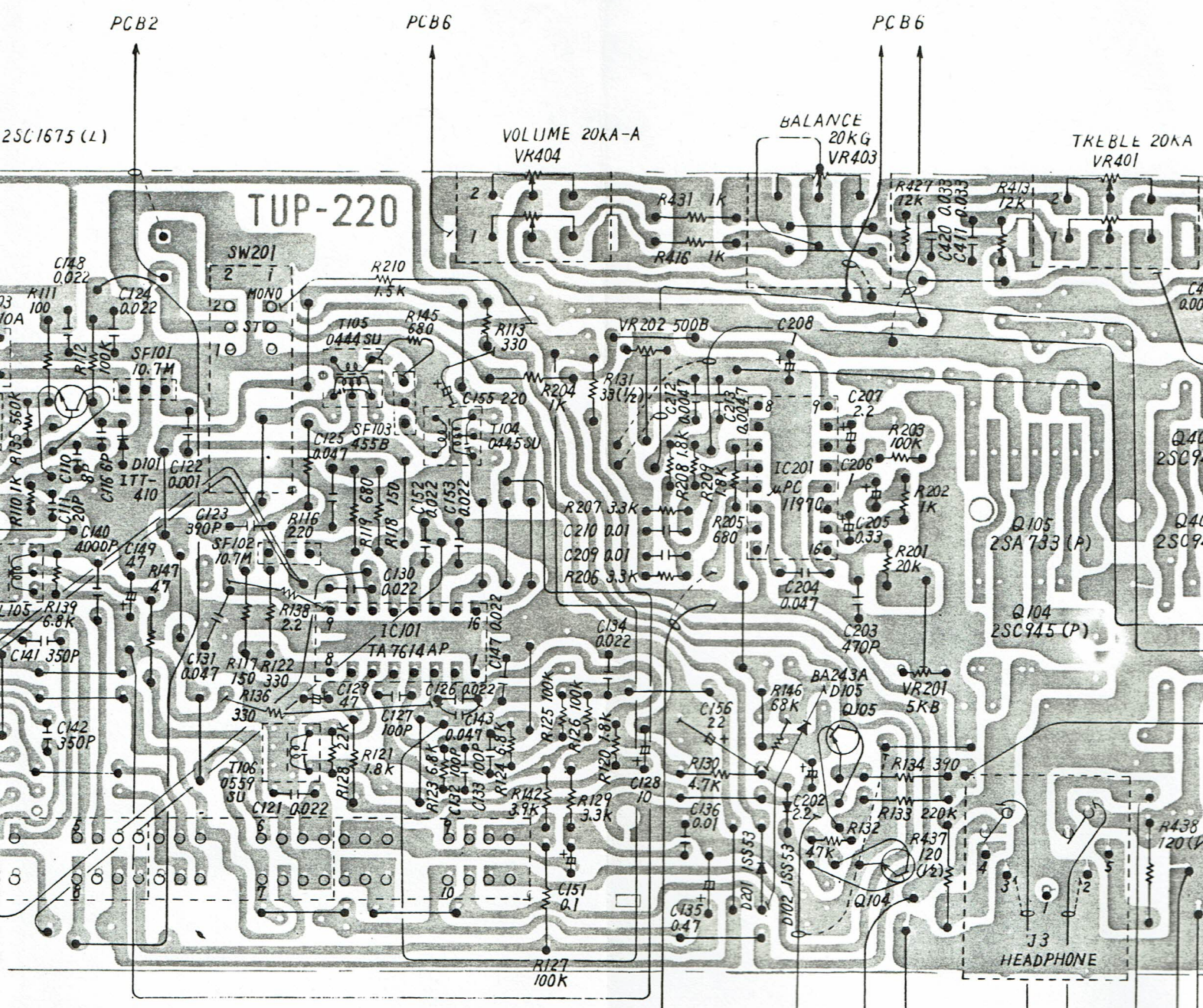

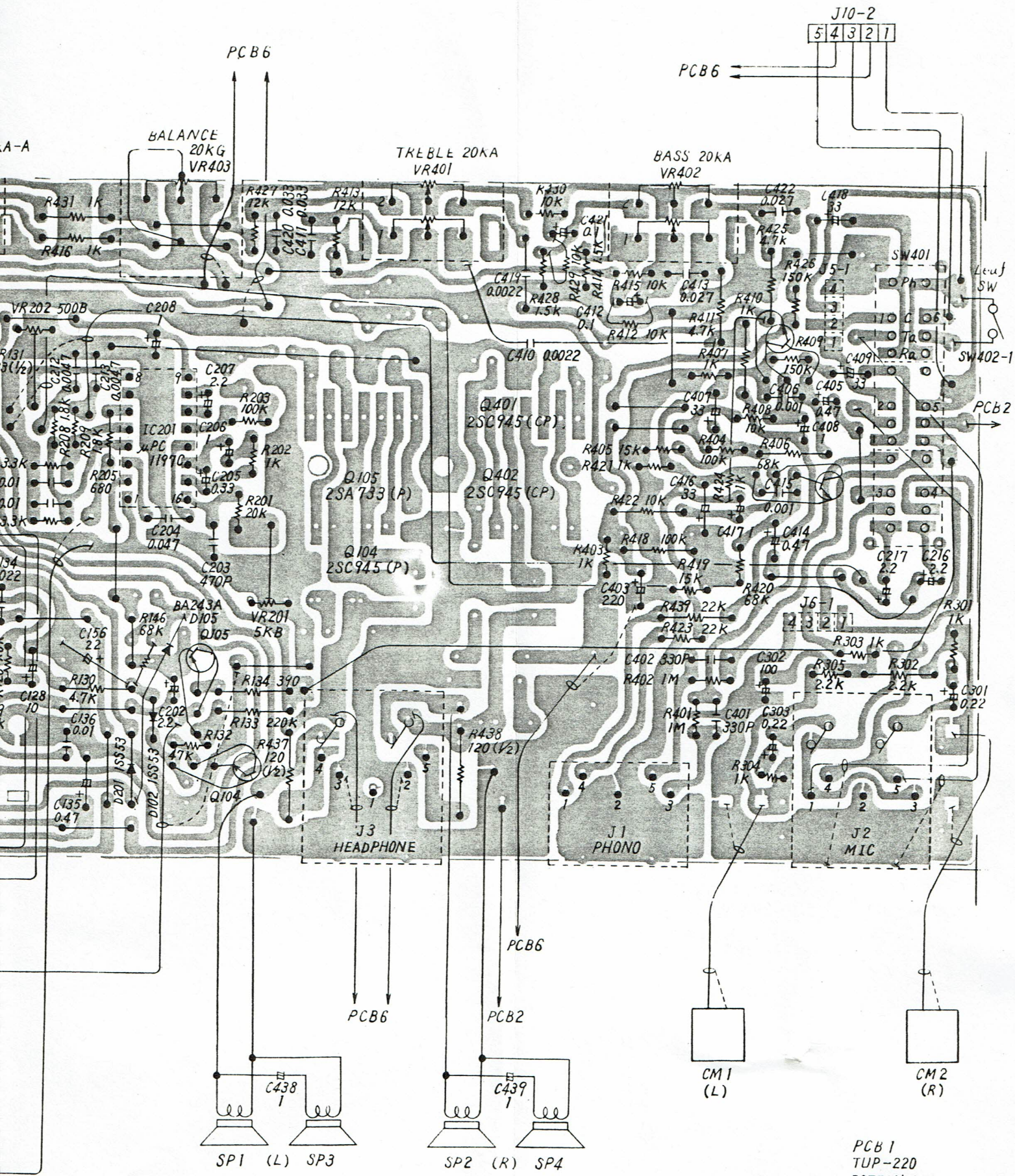

PCB 1
TUP-220
BOTTOM VIEW

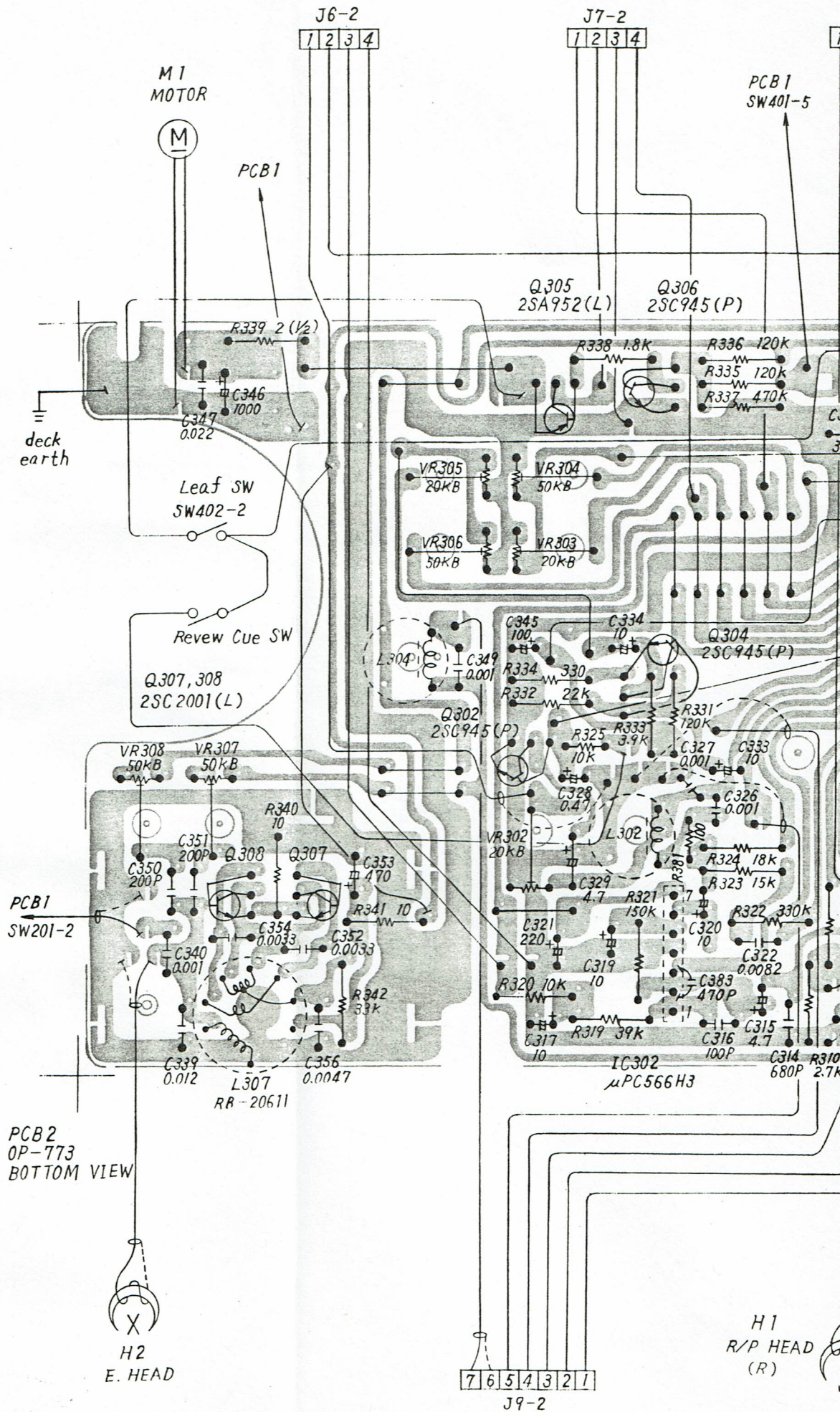

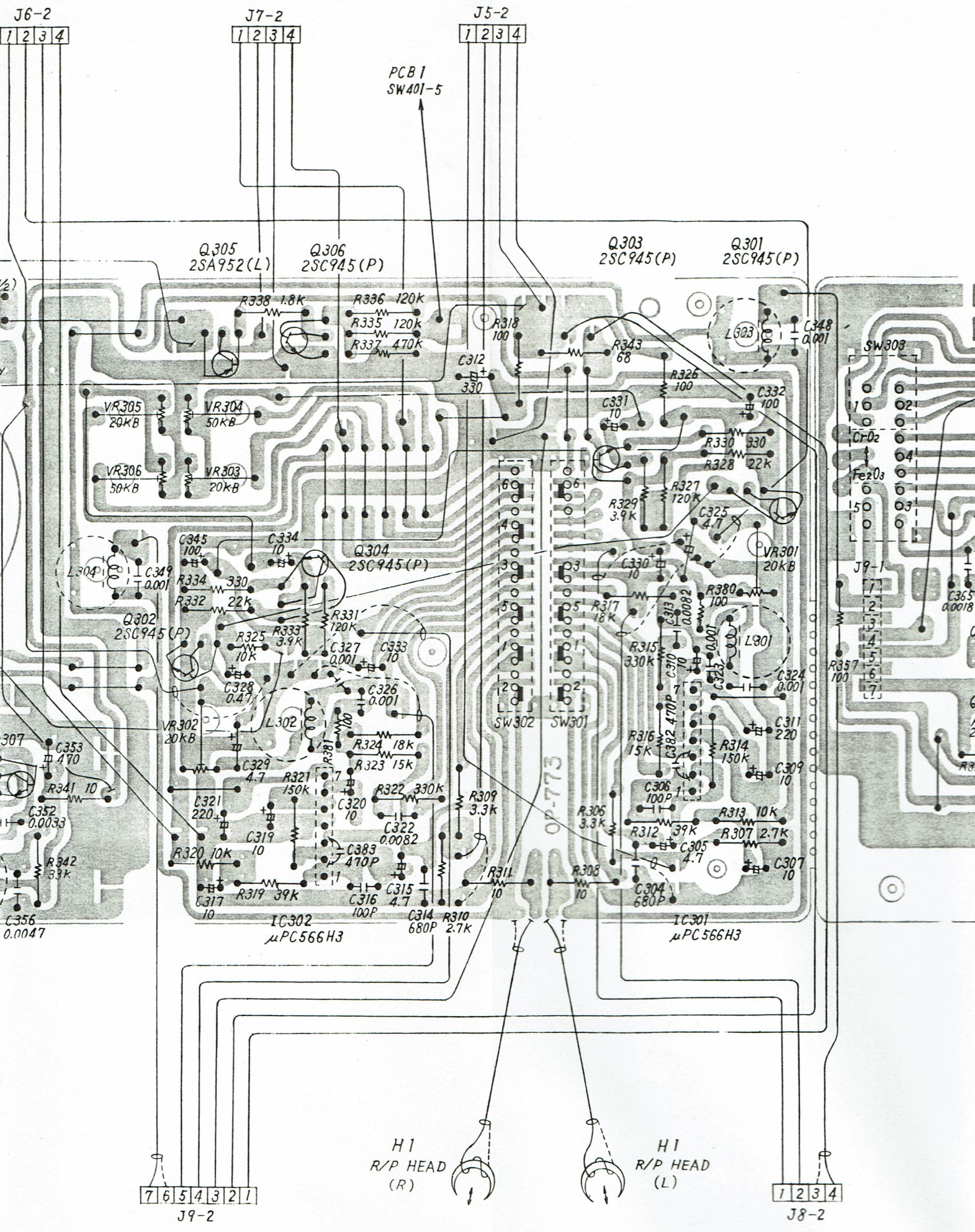

J6-2
1 2 3 4

J7-2
1 2 3 4

J5-2
1 2 3 4

PCB 1
SW401-5

Q305
2SA952(L)

Q306
2SC945(P)

Q303
2SC945(P)

Q301
2SC945(P)

Q304
2SC945(P)

Q302
2SC945(P)

IC302
μPC566H3

IC301
μPC566H3

J9-2
7 6 5 4 3 2 1

H1
R/P HEAD
(R)

H1
R/P HEAD
(L)

J8-2
1 2 3 4

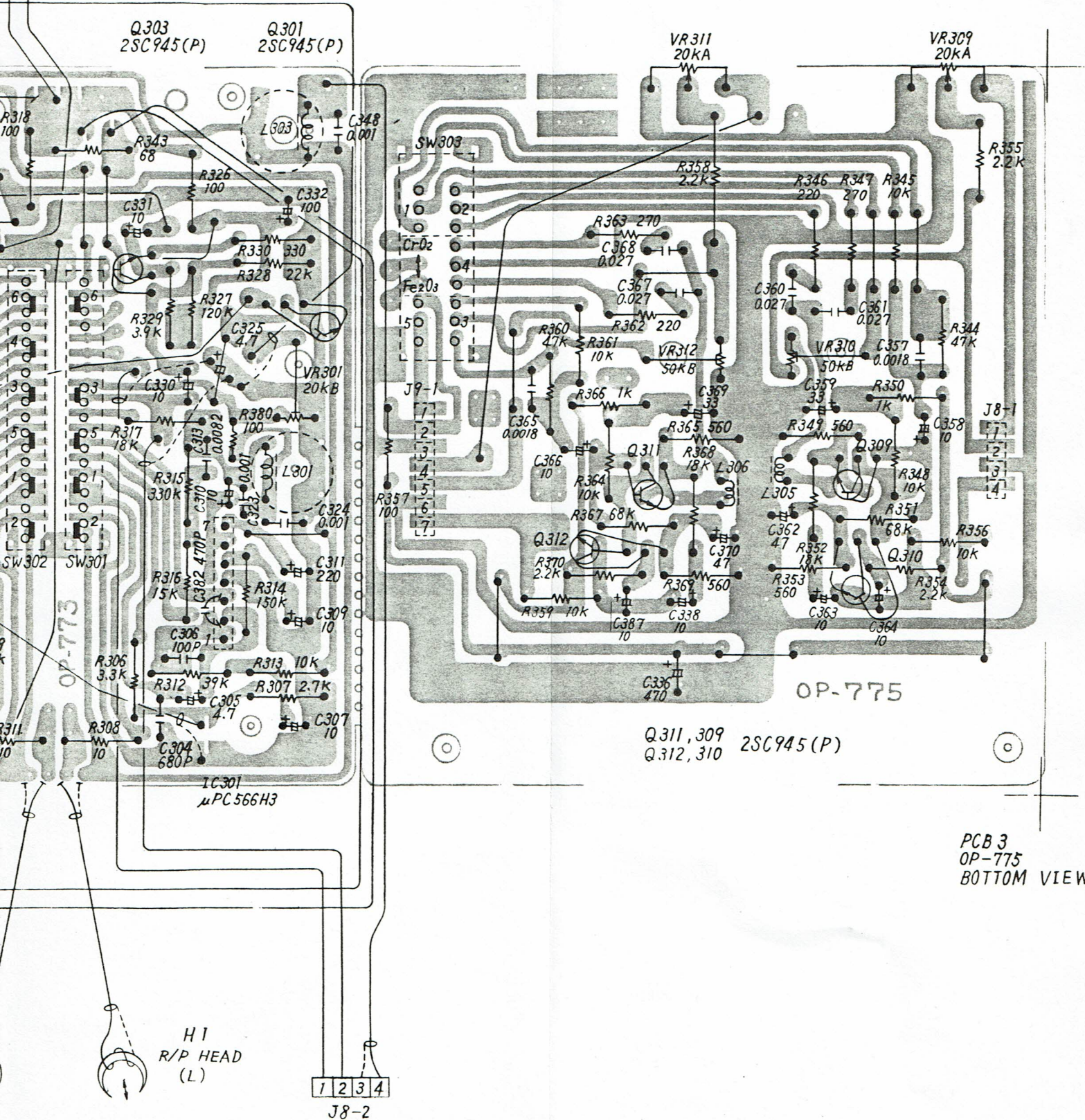

PCB 3
OP-775
BOTTOM VIEW

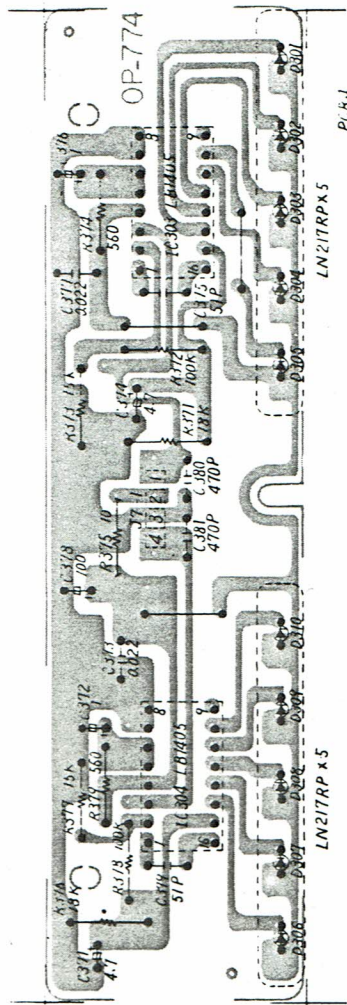

PUB 1
 OP-774
 BOTTOM VIEW

