

ISP[®]

International Sound Products

ELECTRO-DENIS sprl
Radio-TV-HiFi-Electro Ménager
Faubourg de France 2
6830 Bouillon
061 - 466 352

1/600

service manual

*** Tuner**

Amplifier

Cassette - deck

SERIE 200



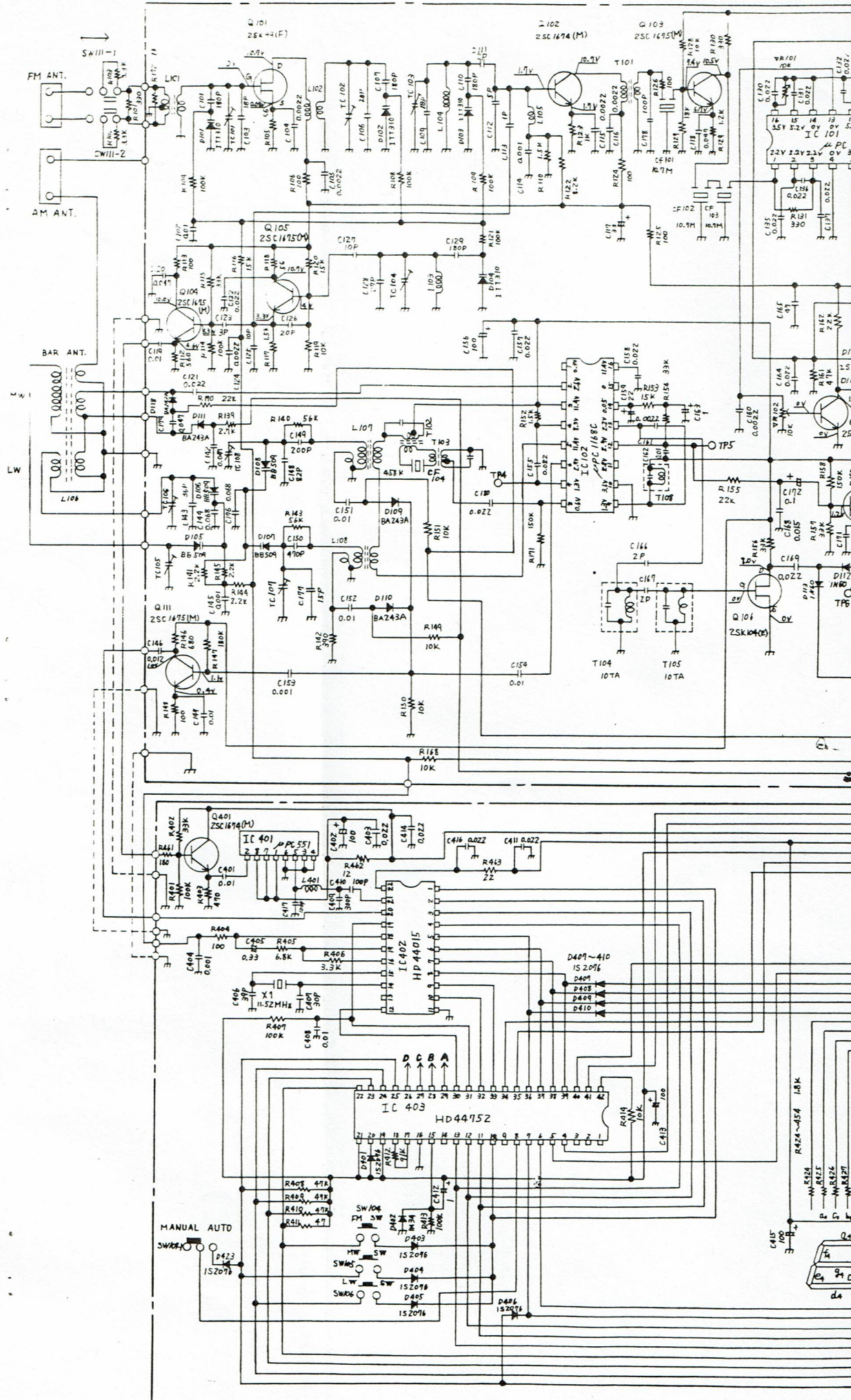

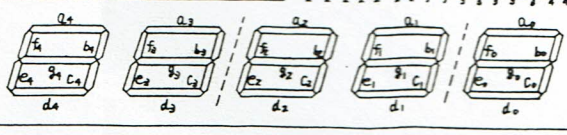
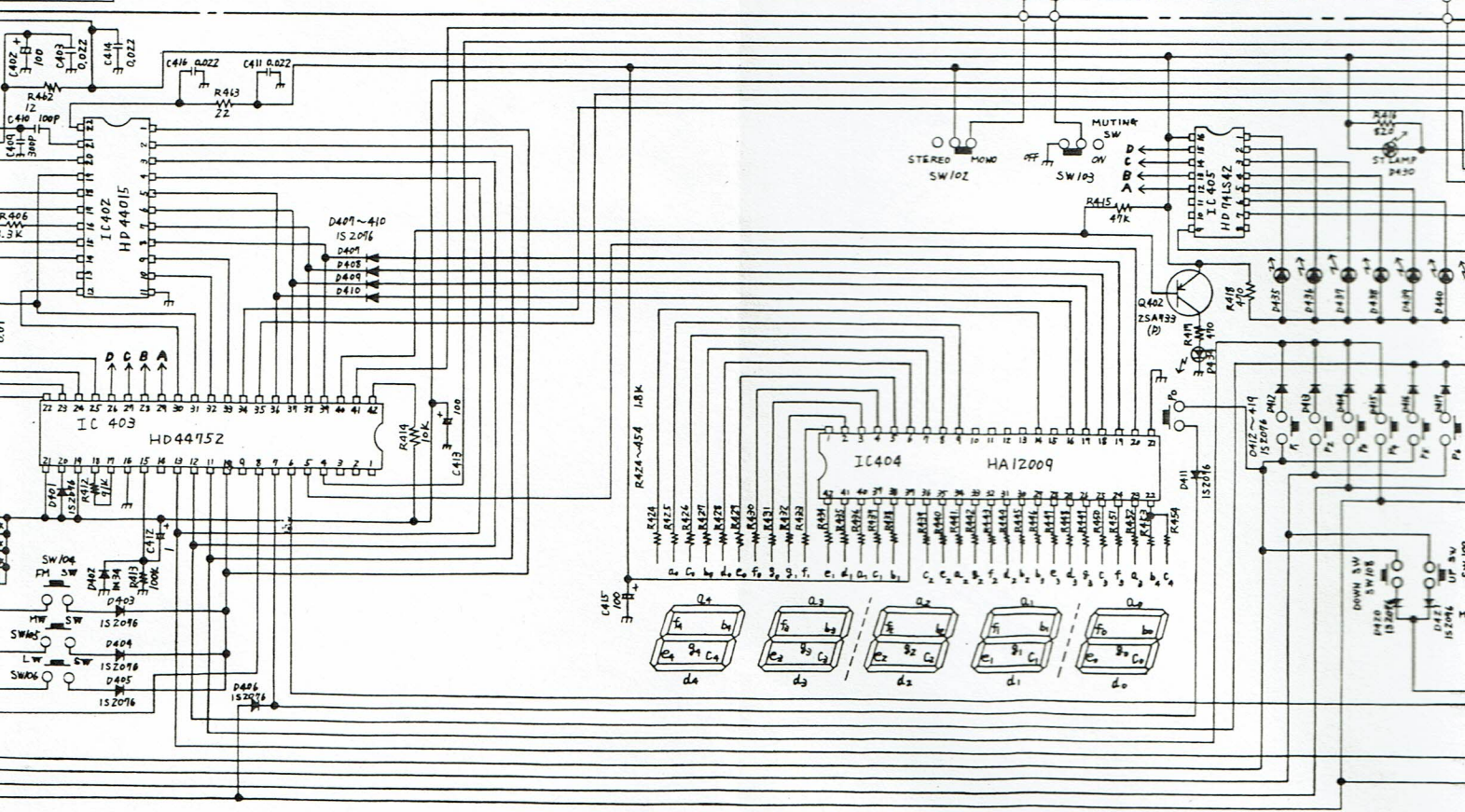
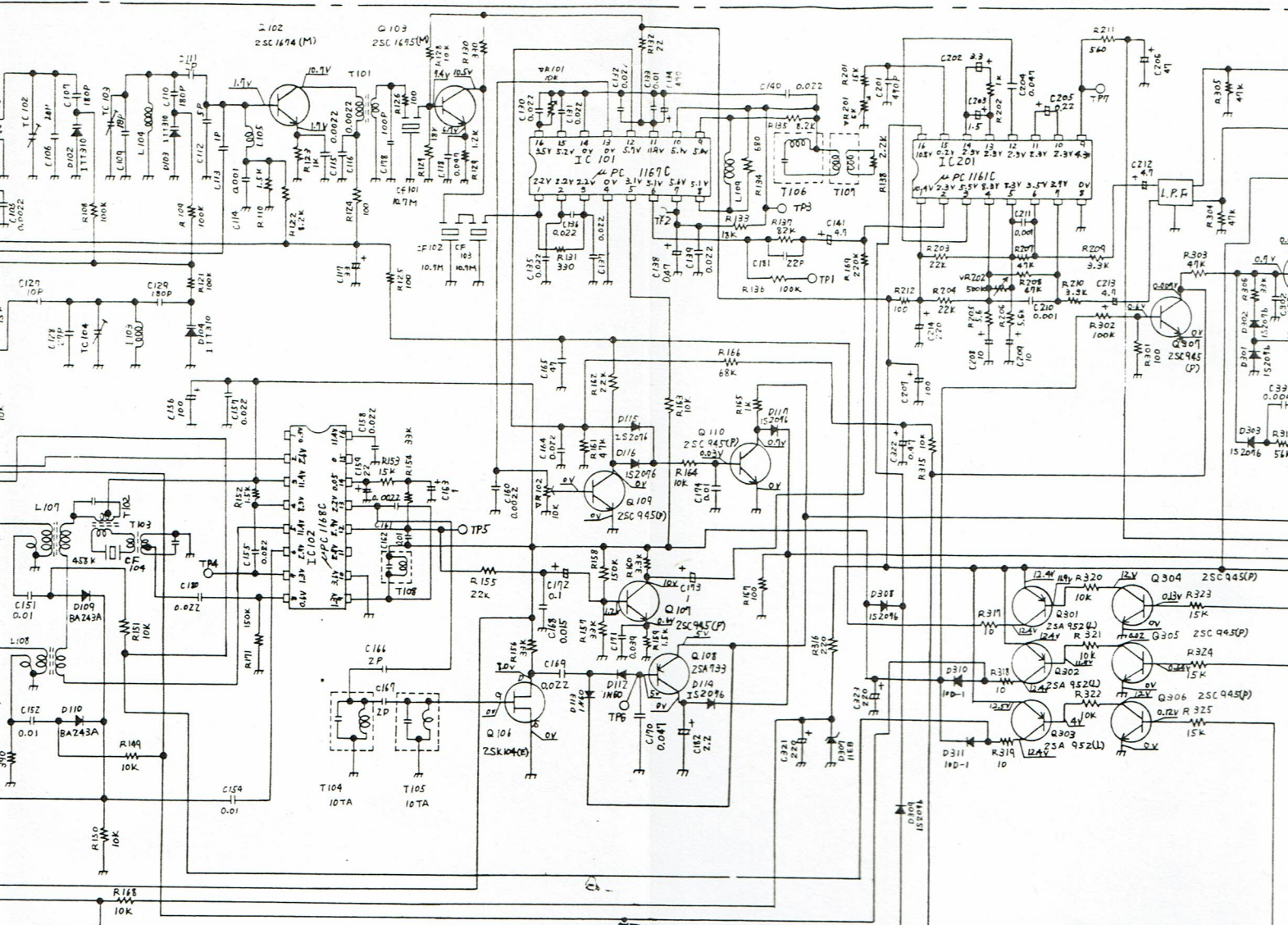

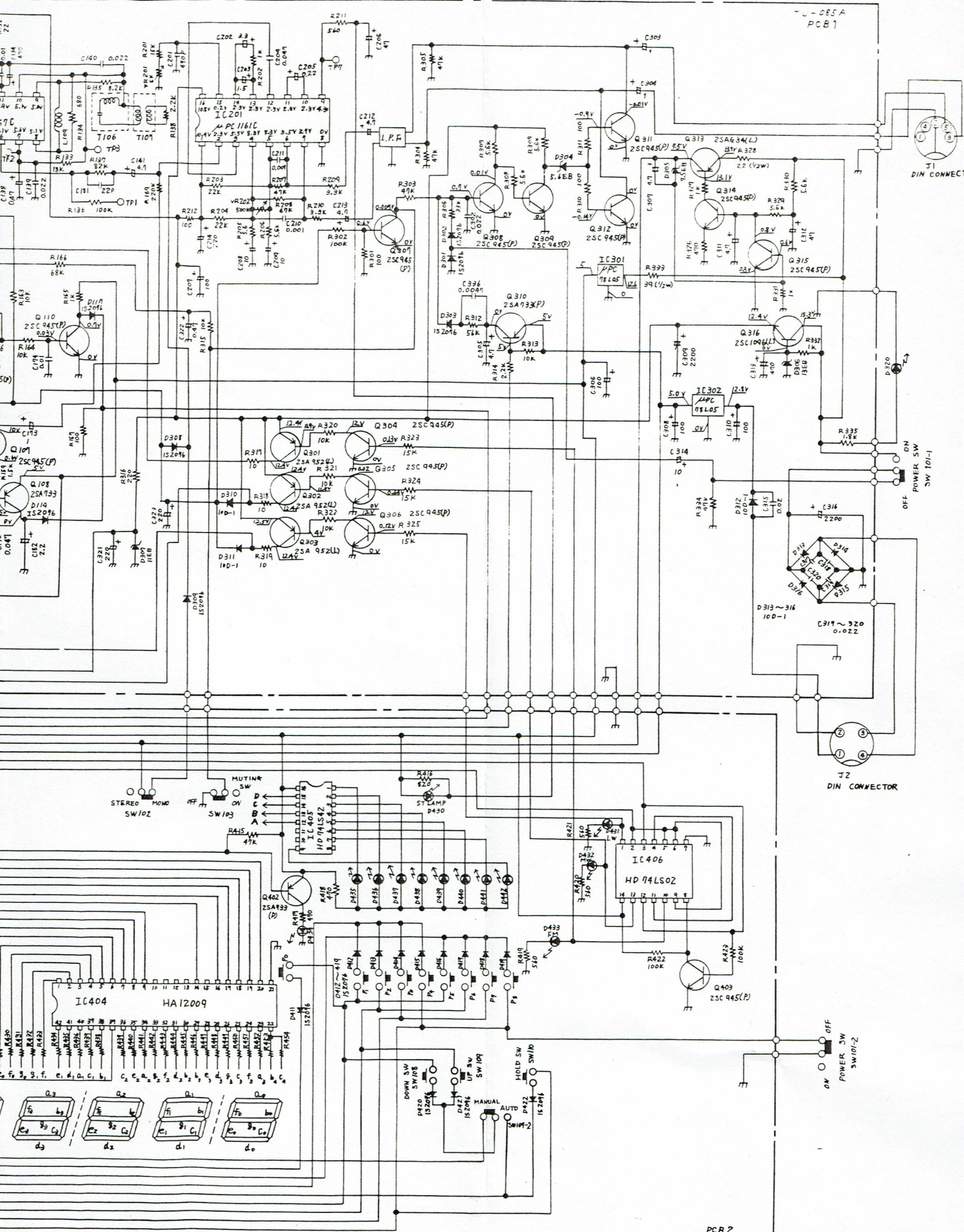

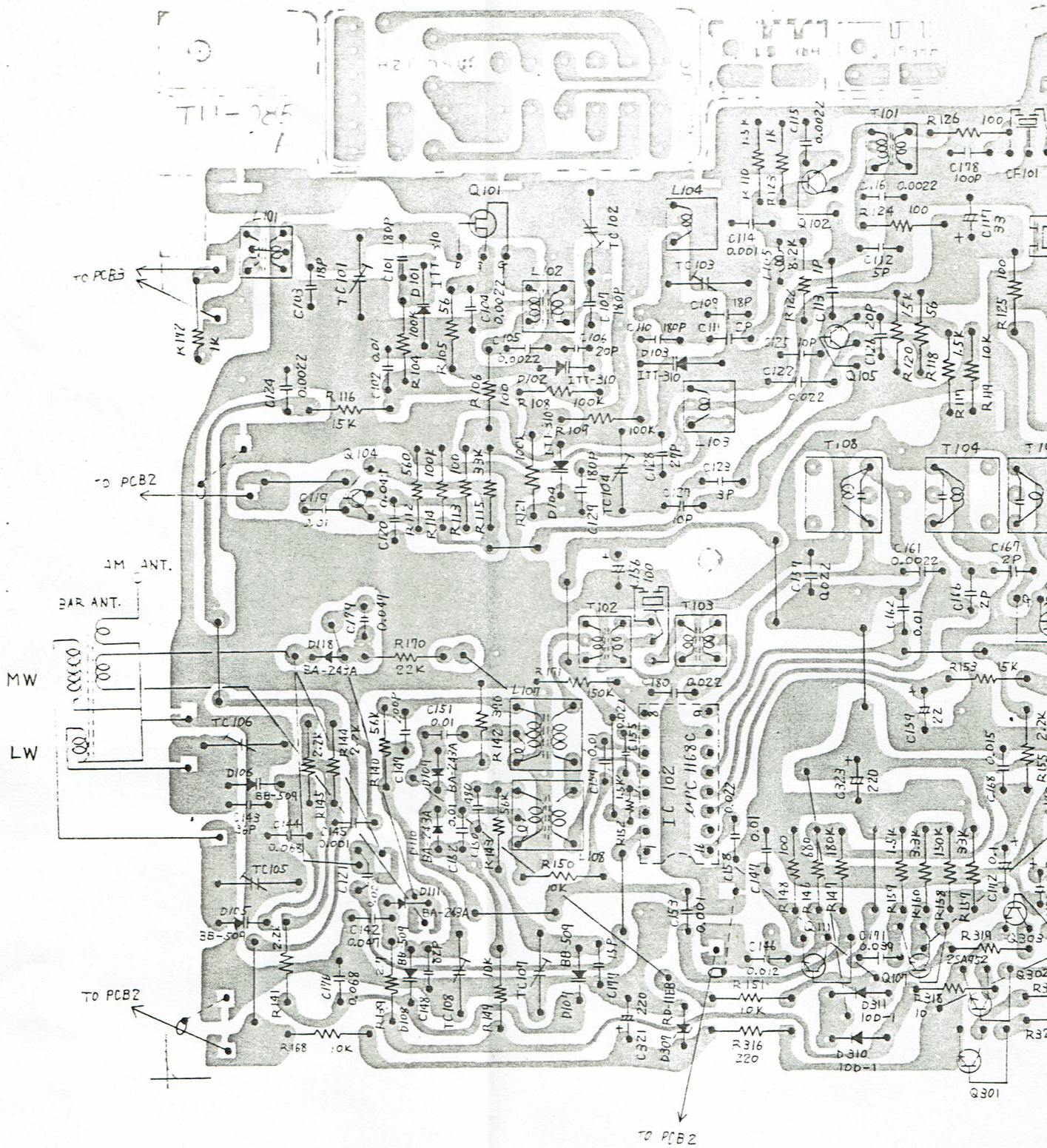

T11-285

121 03 66

TO PCB3

TO PCB2

AM ANT.

BAR ANT.

MW

LW

TO PCB2

TO PCB2

Q301

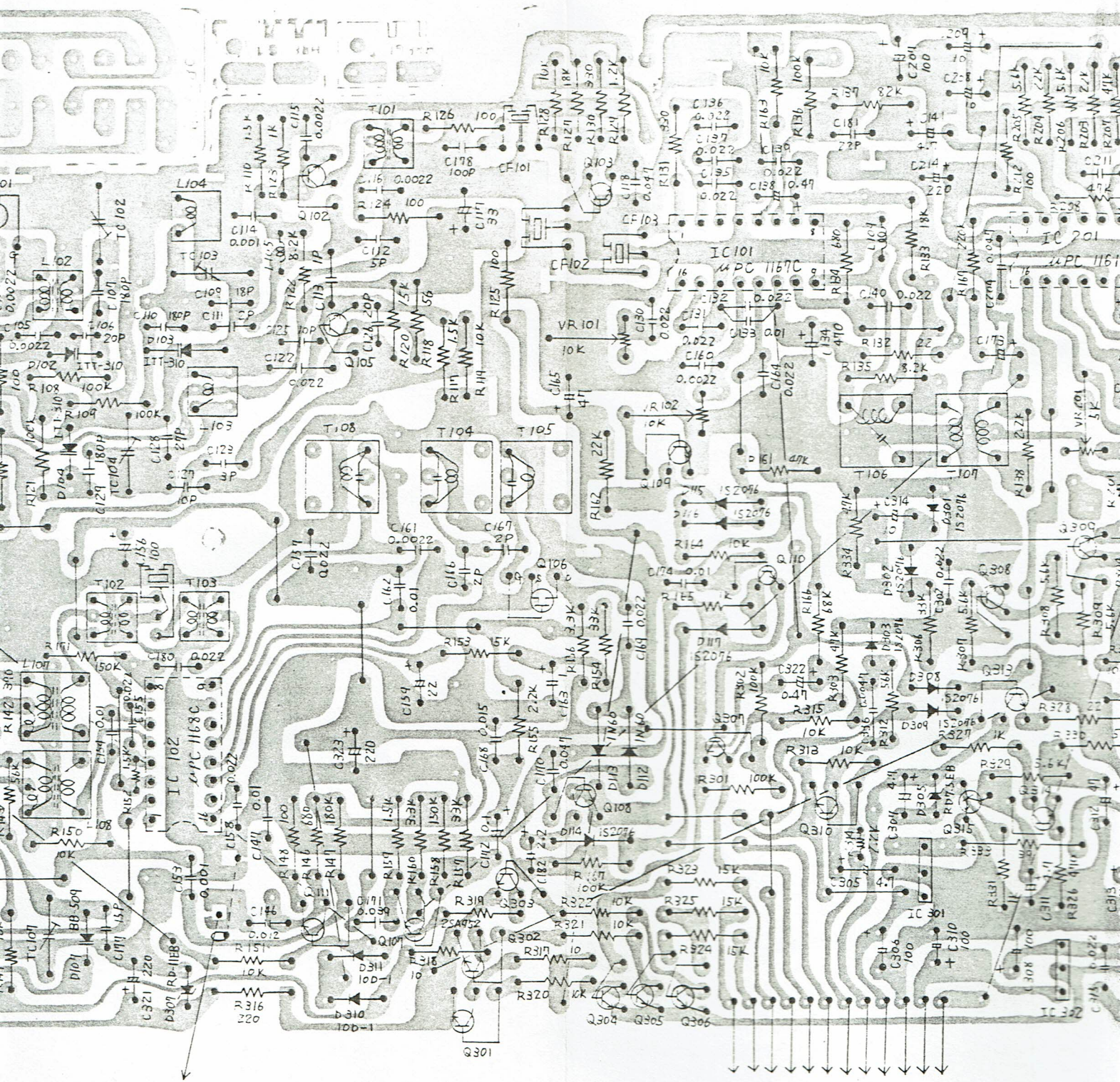

TO PCB 2

TO PCB 2

